

Collection Management

Share the Experience @ Bristol

Wills Hall, University of Bristol

February 2nd 2016

11.30-12.00

From Strategy to Solutions: a National Bibliographic Knowledgebase

Neil Grindley

Head of Resource Discovery, JISC

The National Monograph Strategy

2012 - 2014

The vision

Within 5 years UK researchers and students will have unparalleled access to a distributed national research collection enabled by an open collaborative national infrastructure.

It is only together that we can work to build these ideas and realise the vision of a national research collection that has the potential to transform the experiences and work of researchers and students in the UK.

This report marks a beginning, not an end.

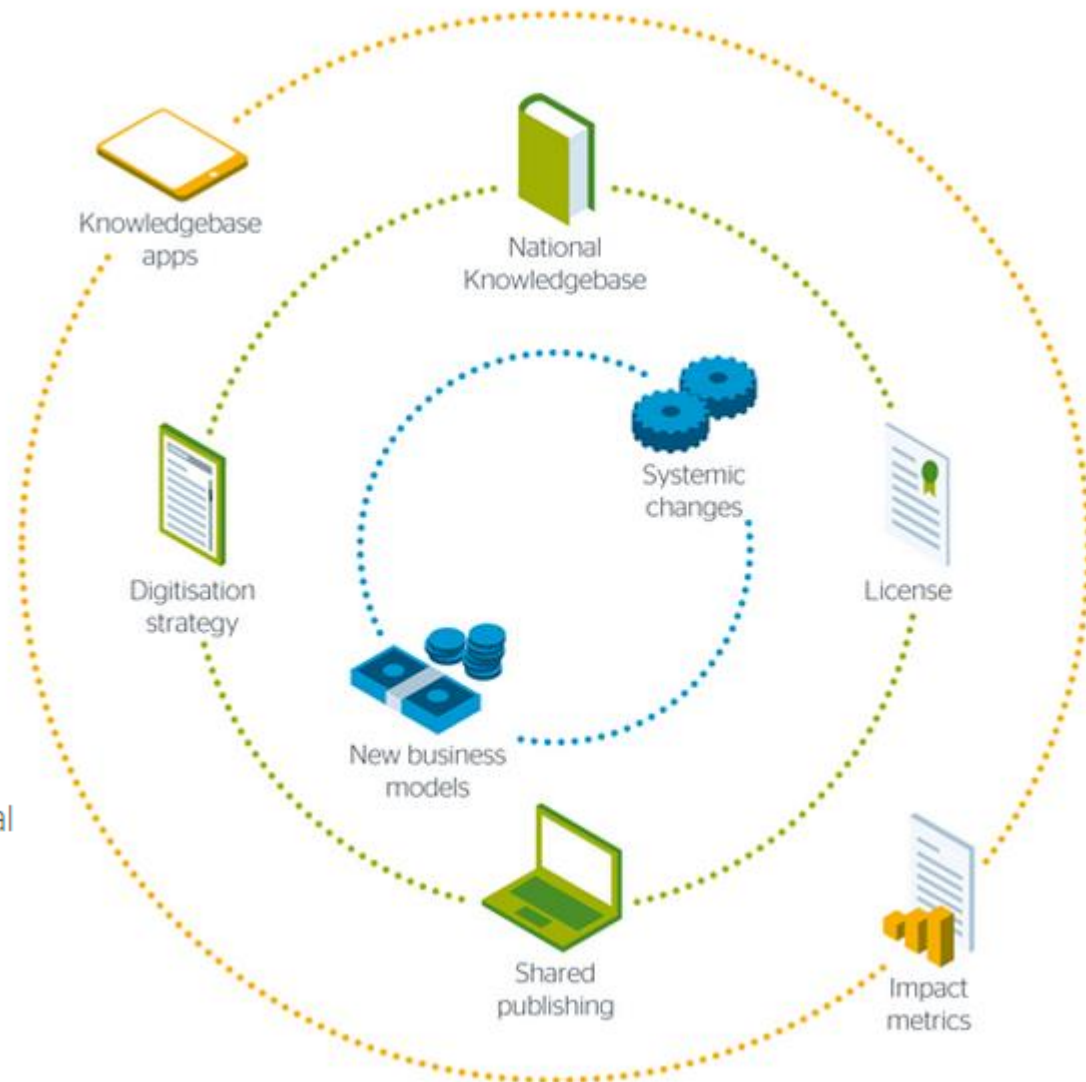

Strategy

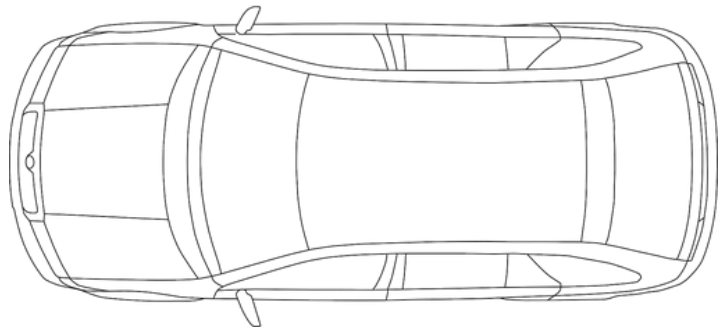
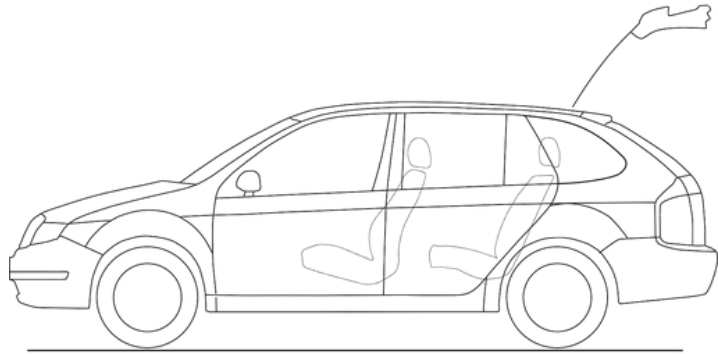
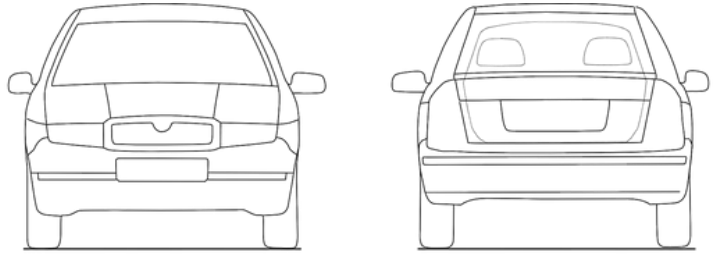

Strategy

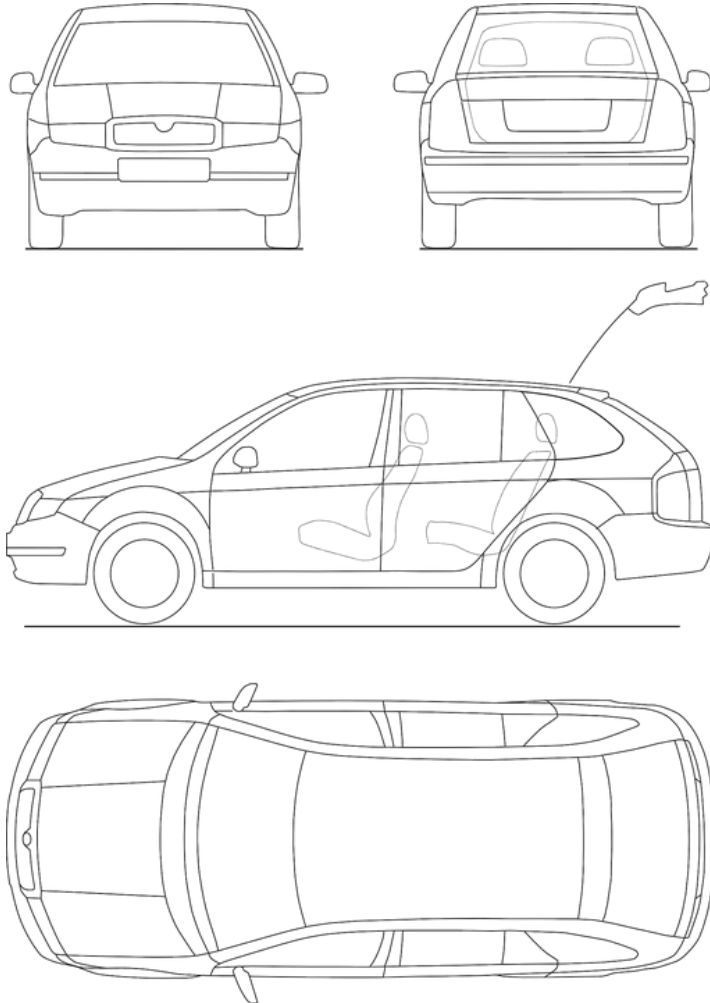

Solutions

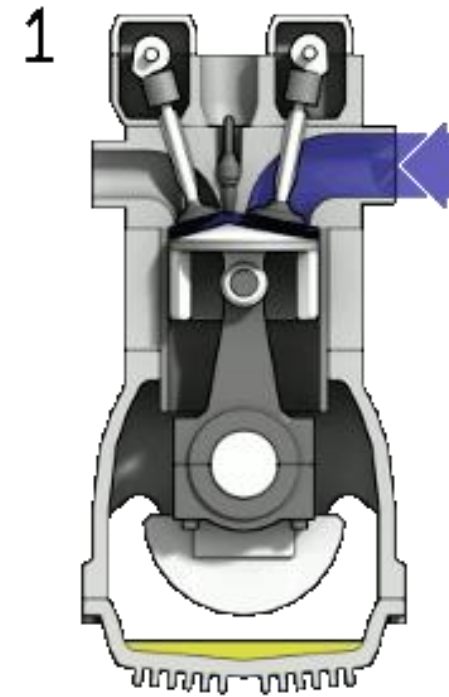

<http://monographs.jiscinvolve.org/wp/>

Monograph Solutions

Working on Bibliographic Data and Digital Access to Books



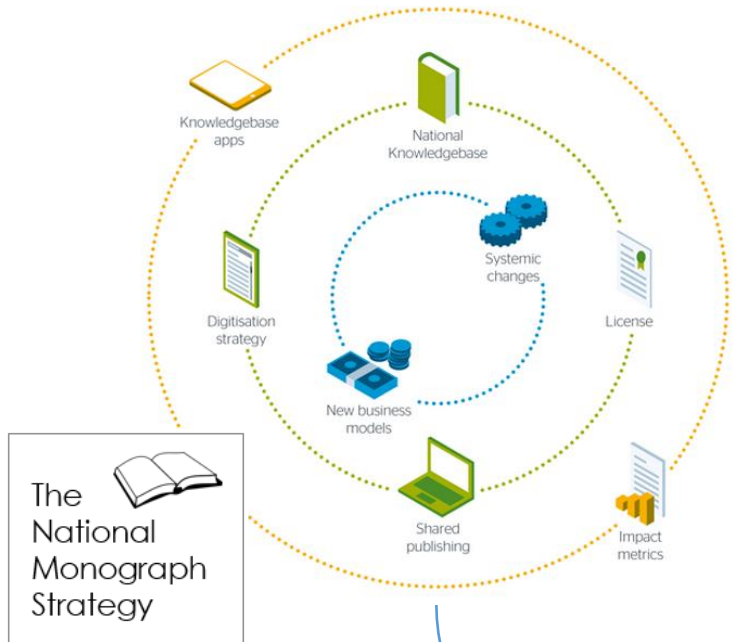

The Bibliographic Services Implications (BSI) Report

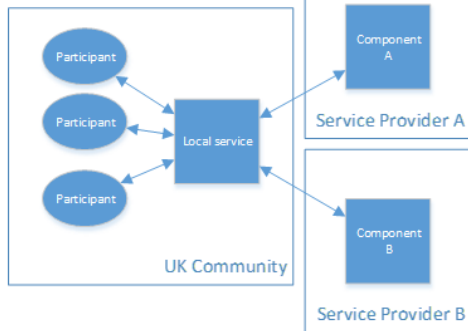

Jisc Library Support Services: Enhancing Efficiency and Effectiveness Report

Jisc Service Portfolio Review



The Bibliographic Data Roadmap Group (BDRG)



The Bibliographic Data Oversight Group

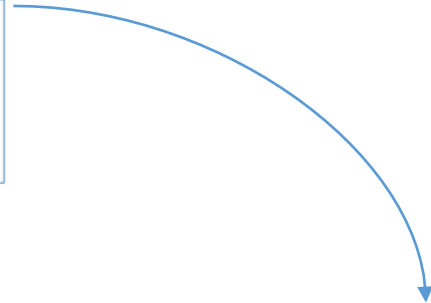
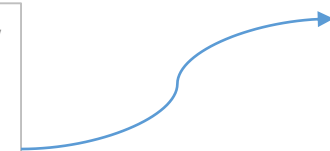
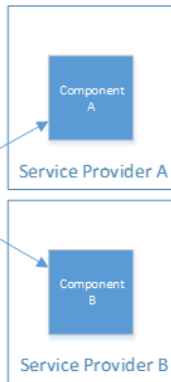
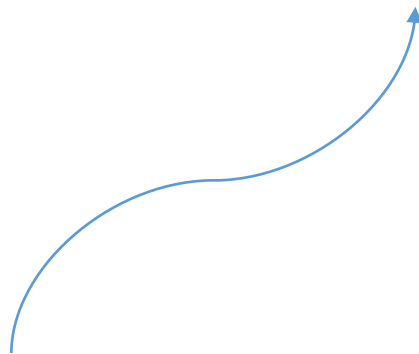

What problems are we trying to solve?

Libraries want to make data-driven decisions about the management of their [book] collections but the data that is currently available does not allow them to do this with confidence

Libraries want to ensure that researchers and learners have sustainable and convenient access to [digital] books but it is currently not obvious what is available or what could readily be made available

How are we going to solve these problems?

Data



UK National Bibliographic
Knowledgebase

Digital
Access

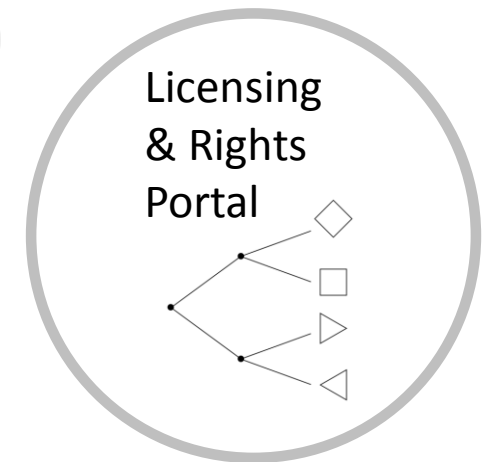

What is a National Bibliographic Knowledgebase?

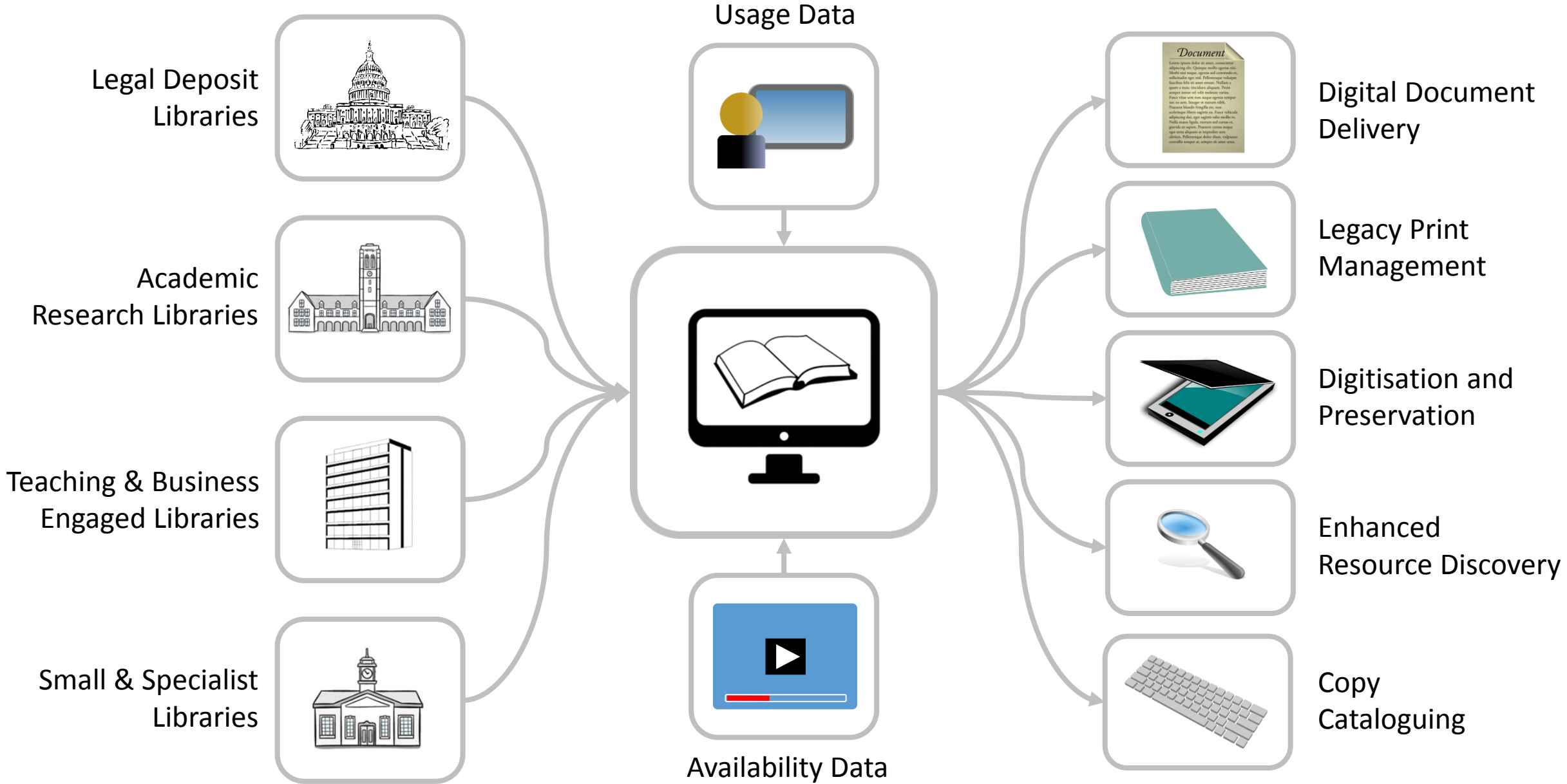

Six objectives of the Knowledgebase

Data-driven strategy

1. To enable UK academic libraries to make cooperative collection management and development decisions with reference to the largest possible aggregation of UK library data

Space Management

2. To help libraries rationalise their print stock and reduce their physical footprint through a better understanding of what is rare and what is common (and what is currently available and what is likely to remain available)

Better e-Book data

3. To contribute to the data flows that will make it easier (cheaper and more efficient) to discover, obtain and manage e-books

Digital Access (Licensing)

4. To support a national level framework for UK F/HE that clarifies rights and permissions to access scholarly digital materials (or where necessary it facilitates the lawful creation of digital copies of inaccessible print materials)

Digital Access (Discovery)

5. To support the discovery and delivery of the best quality and most persistently accessible digital version of scholarly materials wherever they are globally available

Openness / Innovation

6. To allow *any* service provider (including Jisc) to integrate with or build more effective discovery, analysis and management tools/services on top of the most comprehensive, open and best quality aggregation of UK library data that it is possible to build

How does this fit with the current situation?

UK Academic Libraries

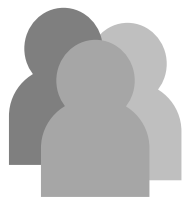
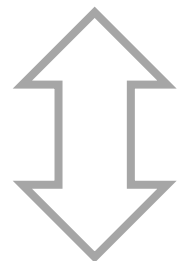

Researchers & Learners

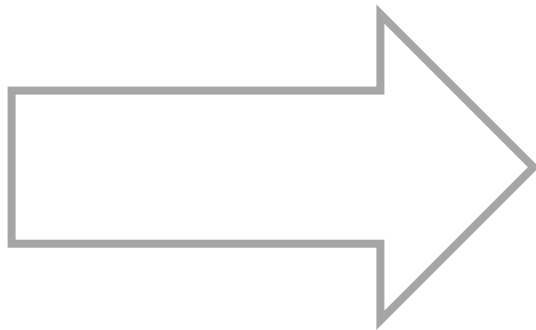

Global Service Provider

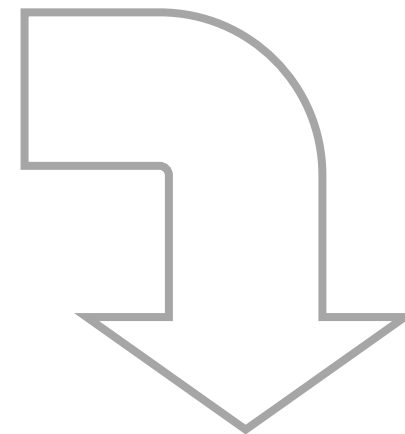

UK National Bibliographic Knowledgebase

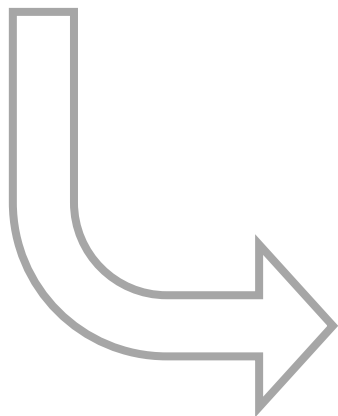

copac*



Jisc
Bibliographic
Data Services

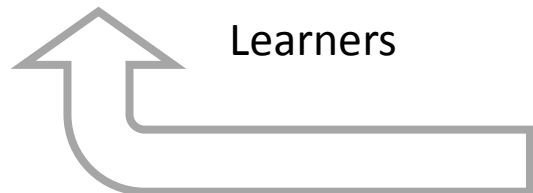

What services might support and exploit the aggregation?

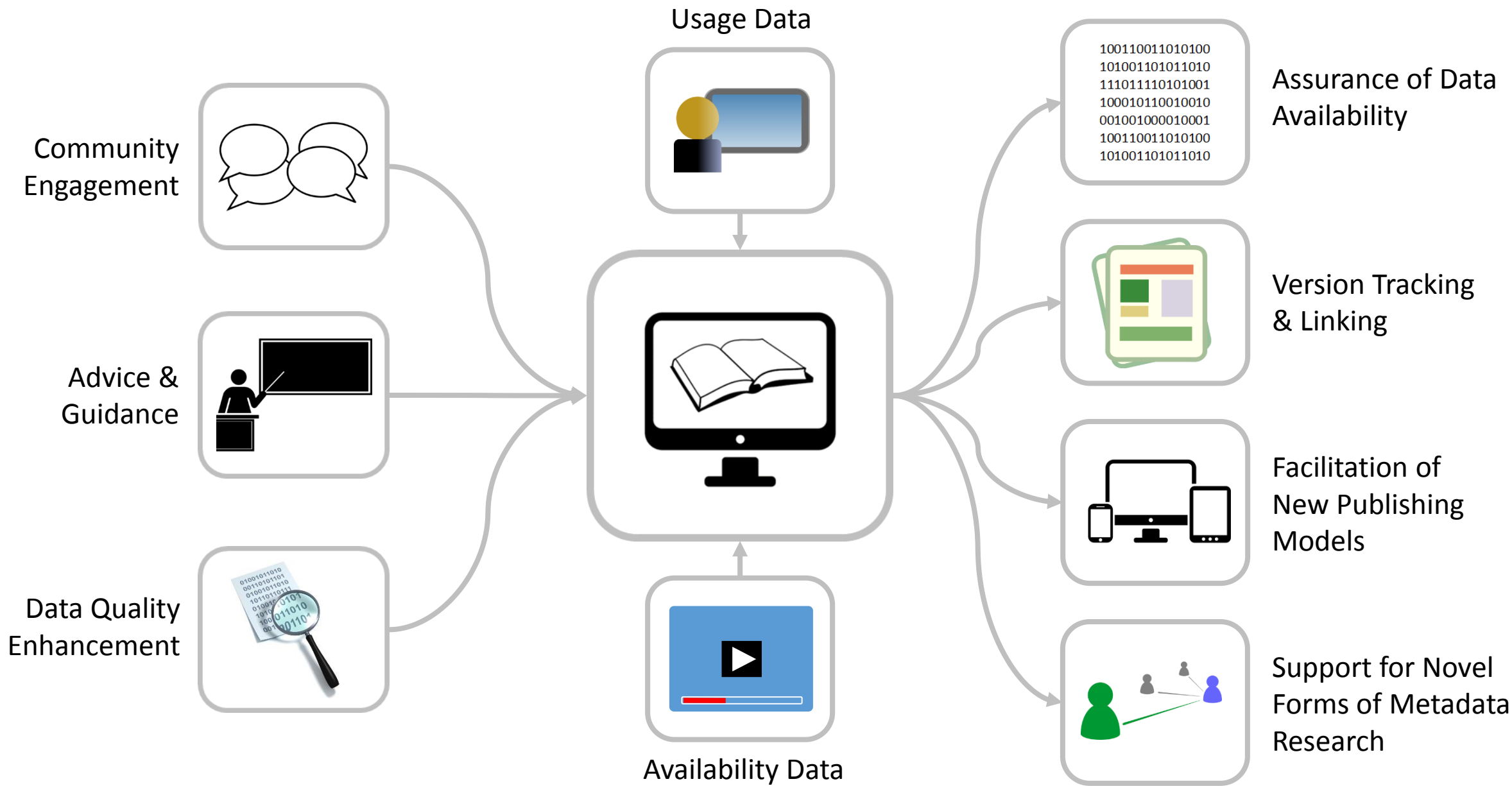

THE
KNOWLEDGEBASE





Investigating access barriers to monographs in digital form – a call for participation



By Karen Colbron on November 23, 2015

monographs

Digital access, monographs

This call for Participation invites librarians in Higher Education institutions to join Jisc as we work through issues relating to access to digital monographs as part of the second phase of the National Monographs Strategy project.

Jisc will award grants of £6,000 to up to ten HEIs to cover participation in the project by two library members of staff, one with strategic oversight of collection management issues, and the other with responsibility for the implementation of day-to-day collection management policies.

The deadline for applications in response to this call is 5pm UK time on **Friday, 8th January, 2016**

(all required to support reading lists or collection development)

Relational aesthetics / Nicolas Bourriaud ; translated by Simon Pleasance & Fronza Woods with the participation of Mathieu Copeland. ISBN: 2840660601; 9782840660606.

Examples of a couple of classic cultural texts could be 'Mythologies.' These might be available as PDFs online

A long list of the Whitechapel series books in our OPAC, <https://libsearch.arts.ac.uk/cgi-bin/koha/opac-search.pl?q=se,phr:%22Documents%20of%20con>

TILLICH, P. (1957). *Dynamics of faith*. London, Allen & Unwin.

Reason for use: requested by Academic Liaison on behalf of research

GRECO, J., & SOSA, E. (1999). *The Blackwell guide to epistemology*. Oxford, Blackwell.

Reason for use: requested by Academic Liaison for a class of 75 students

KAMUSELLA, T., NOMACHI, M., & GIBSON, C. (2016). *The Palgrave handbook of identities and borders*. London, Palgrave Macmillan.

Reason for use: requested by academic in School of History for research

RICHARD JACKSON. (2009). *Contemporary State Terrorism Theory and Practice*. London, Routledge.

Reason for use: Requested by International Relations in 2012 for research

MCILWAIN, C. (2011). *Cross-border migration among Latin America and the Caribbean beyond. Basingstoke, Palgrave Macmillan.*

Reason for use: For teaching and research. Example of complex choices

Dawsonera – available @ £58 for 400 credits, EBL – available @ £58 for multi-user license, EBSCO – available @ £190 for Unlimited Users

RERGO, N., SEMENOV, E. & MYSYKI, I. (2016). *Romano pustikan danj Odesate, Romenvadesko danitlan Odesate.*

Reason for use: Required for research by academic and available as a digital copy could not host. Rights to host given to St Andrews but difficult to find suitable repository for the content so decision made to print hard copy for library collection. Constantly updating publication so digital would have been far more efficient and accessible.

Titles	Usage
Chilcote, Ronald H., comp. (1972). <i>Emerging nationalism in Portuguese Africa: documents</i> . Stanford, Calif., Hoover Institution Press, Stanford University	Chapter requested as part of a reading list for undergraduate course. Excluded US title. CLA confirmed that Hoover Institution Press is separate entity to Stanford University Press and is therefore not OK to scan. No e-book available to purchase
Portugal. Ministerio dos Negocios Estrangeiros. (1973). <i>Portuguese Africa: an introduction</i> . Lisbon: The Ministry	Chapter requested as part of a reading list for undergraduate course. CLA don't have an agreement with Portugal. The fact that it is a government publication does not make a difference
Vickrey, John F. (2009). <i>Beowulf and the illusion of history</i> , Lehigh University Press.	Book requested for an undergraduate teaching course. Print copy too expensive and e-book not available
Gross, Michael B., (2005). <i>The war against Catholicism: liberalism and the anti-Catholic imagination in nineteenth-century Germany</i> . Ann Arbor, Mich. : University of Michigan Press	Book requested for an undergraduate teaching course. Outside the CLA licence (excluded work or excluded territory). E-book not available to purchase
Bacon, F and Rees, G. (ed.). (1984). <i>Francis Bacon's natural philosophy: a new source: a transcription of manuscript Hardwick 72A</i> . Chalfont	Book requested for an undergraduate teaching course. E-book not available to purchase

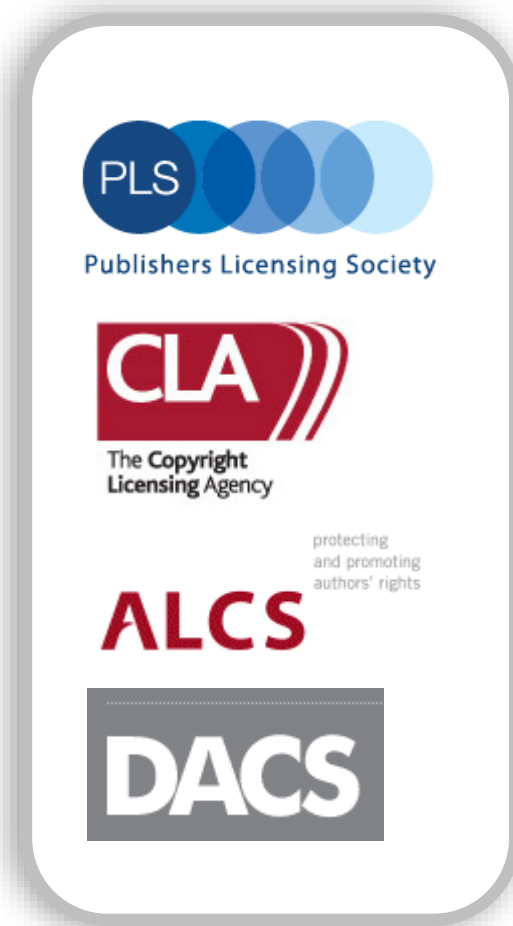
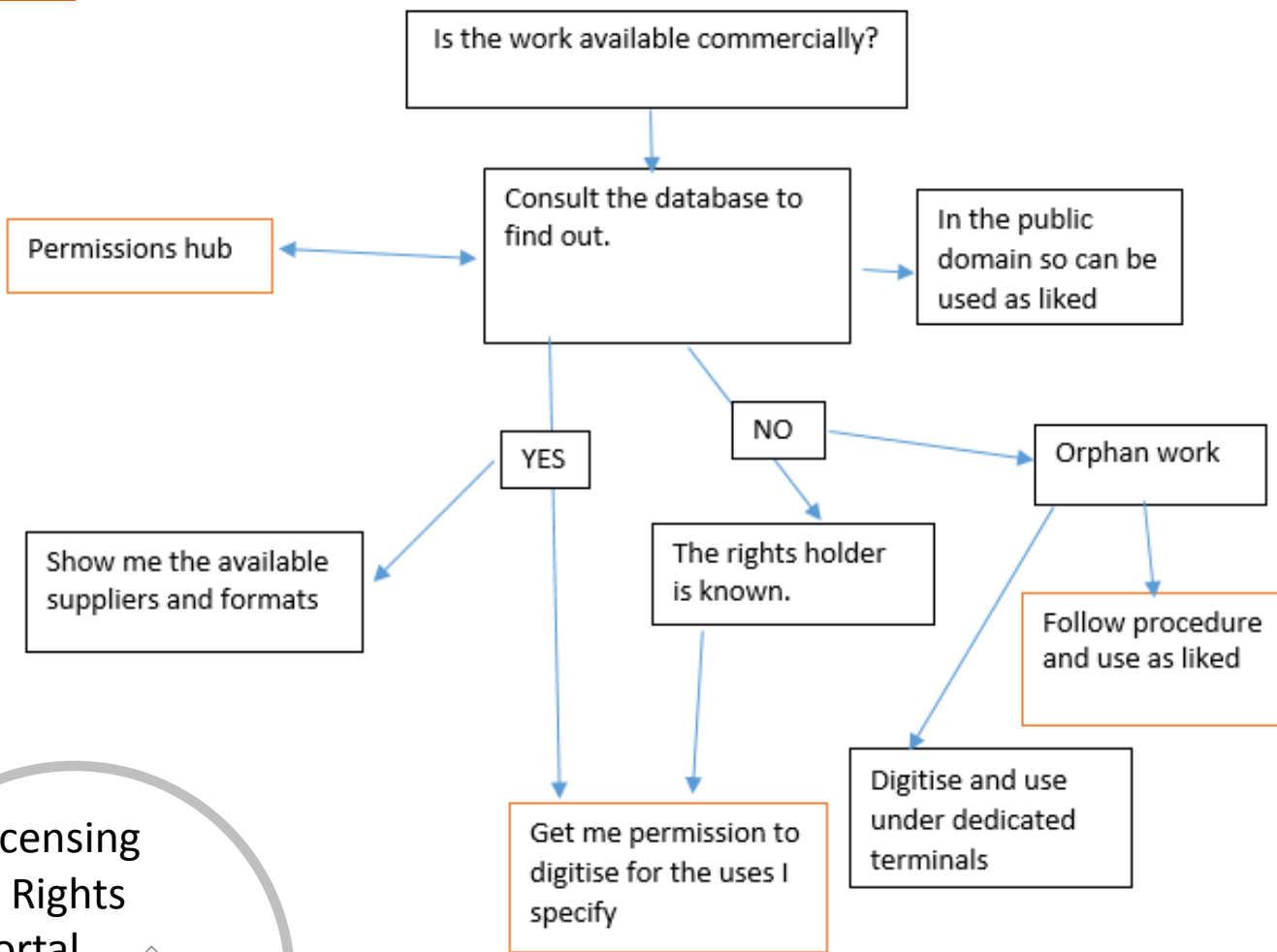

Some Questions for the Breakout Session ...

1. If we want to have a coordinated distributed national collection – what would our vision and mission statement be?
2. What is the most important function that a National Bibliographic Knowledgebase should provide?
3. Journals are easy: books are hard – should we keep them separate?
4. The National Bibliographic Knowledgebase is going to take a lot of time and effort to build. What might the biggest problems be?